

# LuK Repair Solution for Dry Double clutches

Removal and Installation  
Special Tools / Failure Diagnosis

**Audi, SEAT, Škoda, Volkswagen 7-speed transmission 0AM & 0CW**



## Schaeffler in the Automotive Aftermarket – more innovation, more quality and more service.



### Schaeffler REPERT – the service brand for garage professionals.

With REPERT, we offer a comprehensive service package for our products and repair solutions. Looking for specific information about damage diagnosis? Are you in need of particular tools to help make your every-day garage routine easier? Whether online portal, service hotline, installation instructions and videos, training seminars, or events – you get all technical services from a single source.

Register now for free, in just a few clicks, at: [www.repxpert.com](http://www.repxpert.com).

### Schaeffler in the Automotive Aftermarket – always the first choice for vehicle repair.

Whenever a vehicle needs to go to the garage, our products and repair solutions are first choice to fix them. With our system competence in transmission, engine, and chassis, we are a reliable partner around the world. Whether passenger cars, light and heavy commercial vehicles, or tractors – our optimally tuned components allow fast and professional parts replacement.

Our products are based on a comprehensive systems approach. Innovation, technical expertise, and the highest material and manufacturing quality make us not only one of the leading development partners for vehicle manufacturers, but also a pioneering provider of value-retaining spare parts and complete repair solutions for clutches and clutch release systems, engine and transmission applications, and chassis applications in original-equipment quality – right up to the appropriate special tools.

For over 50 years, we have offered everything needed for transmission repair under the LuK brand. Besides the LuK RepSet family and products for the entire hydraulic release system for professional clutch repair, the portfolio also includes the dual mass flywheel and components for expert repair of transmissions and differentials. It also includes professional solutions for transmission repair of commercial vehicles and tractors.

SCHAEFFLER  
**REPERT**



The content of this brochure shall not be legally binding and is for information purposes only. To the extent legally permissible, Schaeffler Automotive Aftermarket GmbH & Co. KG assumes no liability out of or in connection with this brochure.

Copyright ©  
Schaeffler Automotive Aftermarket GmbH & Co. KG  
February 2020

All rights reserved. Any copying, distribution, reproduction, making publicly available or other publication of this brochure in whole or in extracts without the prior written consent of Schaeffler Automotive Aftermarket GmbH & Co. KG is prohibited.

## Content

	<b>page</b>
<b>1 Diagnostics of double clutch transmission</b>	<b>4</b>
1.1 General notes on testing the system	4
1.2 Testing for wear	5
1.3 Visual inspection	5
1.4 Noise	5
1.5 Disconnection problems and slipping clutch	5
1.6 Diagnostics	5
1.7 Damage patterns	6
<b>2 Distinguishing features of double clutch systems – 1st and 2nd generations</b>	<b>7</b>
<b>3 Description and scope of the LuK RepSet 2CT – 1st and 2nd generations</b>	<b>8</b>
<b>4 Description and scope of the LuK special tools</b>	<b>10</b>
4.1 Basic tool kit	11
4.2 Volkswagen tool kit (Audi, SEAT, Škoda, Volkswagen)	12
4.3 Supplementary tool kit	13
<b>5 Removal and installation of the double clutch</b>	<b>14</b>
5.1 Notes on repairs	15
5.2 Brief description of the repair process	15
5.3 Removal of the double clutch	16
5.4 Removal of the engaging system – 1st generation	21
5.5 Installation of the engaging system – 1st generation	23
5.6 Removal of the engaging system – 2nd generation	26
5.7 Installation of the engaging system – 2nd generation	28
5.8 Setting the engaging system – 1st and 2nd generations	31
5.9 Preparation of the transmission input shafts	36
5.10 Installation of the double clutch	37

## 1 Diagnostics of double clutch transmission

### 1.1 General notes on testing the system

Before repairing the double clutch, a few key questions must first be clarified with the customer in order to localise the error as much as possible.

Once the vehicle is ready for driving, we recommend carrying out a test drive. The customer should drive in order to demonstrate any possible malfunctions.

#### Specific questions for the customer:

- What exactly is not working or what is the exact complaint?
- When did the problem begin?
- Did the problem start suddenly or did it develop gradually (slowly)?
- When does the problem occur?  
Sporadically, often, always?
- What driving condition is the vehicle in when the problem occurs?  
For example, when starting, accelerating, decelerating, when the engine is cold or warm?
- What is the mileage of the vehicle?
- Is the vehicle subjected to extraordinary loads?  
E.g. towing a trailer, high load capacity, frequent hill climbs, operated as taxi, fleet car, rental car, driving school?
- What is the driving profile?  
Urban vehicle, short journeys, intercity, motorway?
- Have repairs already been carried out on the clutch/transmission system?  
If so, at what mileage? What was the cause of that complaint? What repairs were carried out?

#### General tests on the vehicle

Before starting the repair on the vehicle, the following points should be checked:

- Defect code entries in control unit (engine, transmission, clutch, comfort, CAN-BUS)
- Battery power

### Double clutch on the engine side



### Double clutch on the transmission side



### 1.2 Testing for wear

In addition to the general tests, wear testing can be carried out on the double clutch system. This must be performed as follows:

1. The engine must be warm
2. Carry out a test drive in Tiptronic mode
3. When you reach 6th gear, maintain the speed at approximately 1000 - 1500 rpm
4. Then accelerate fully (ATTENTION: No kickdown)
5. Watch the rev counter
6. If a fluctuation in engine speed of up to 200 rpm occurs when accelerating, the wear limit of the double clutch has been reached
7. The wear limit is not reached if the engine speed increases steadily
8. The test must be repeated from step 3 in 7th gear

### 1.3 Visual inspection

Prior to each repair, the area of the clutch system should be checked for leaks and damage as a matter of course. Damage caused by parts that have broken off or oil leaks due to defective seals or sealing rings must first be rectified before the clutch is replaced. If there is oil on the clutch, replace it.

### 1.4 Noise

If noise is heard from the double clutch/flywheel area, ensure that the noise is not emanating from surrounding components such as the emission system, heat guard plates, engine suspension damping blocks, auxiliary equipment etc. The radio, air conditioning and ventilation systems should be switched off during the noise investigation. A stethoscope can also be used in the workshop, for example, to locate the source of the noise.

### 1.5 Disconnection problems and slipping clutch

Before the transmission is removed and the clutch is replaced, a diagnosis should first be carried out with a suitable diagnostic device. If no nonconformity is stored in the memory of the control unit, there is a high probability that the malfunctions are being caused by the mechanical installation of the double clutch system. An incorrect clearance is one possible cause here. If these defects occur after the repair, the engaging system has been set incorrectly and this must be repeated (see page 31).

### 1.6 Diagnostics

The transmission and clutch electronics can be diagnosed using a suitable diagnostic device. Prior to each repair, the contents of the error memory should be read and, if possible, retained as a printout. The error memory report provides an initial overview of the system errors and forms the basis for further repair measures. It provides the necessary data for assessing the errors (important when contacting the LuK INA FAG Service Centre or in the event of a warranty claim).

Finally, a basic setting of the clutch system must be carried out with a suitable diagnostic device after any work on the double clutch.



### 1.7 Damage patterns

#### DMF anti-backlash spring

**Problem**

- Rattling

**Cause**

- The retaining lugs on the anti-backlash spring are broken

**Remedy**

- Replace DMF

**Note:**

Broken parts of the anti-backlash spring can also be found in the double clutch. Replacement of the double clutch is therefore recommended!

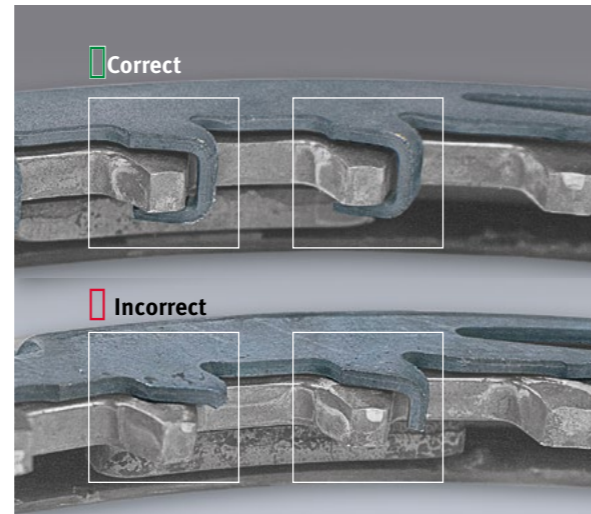

#### DMF anti-backlash spring

**Problem**

- Rattling

**Cause**

- The preload of the anti-backlash spring is too weak. There must be no visible gap between the anti-backlash spring and the gear tooth of the drive plate. The force of the internal spring must push the anti-backlash spring back into its initial position

**Remedy**

- Replace DMF

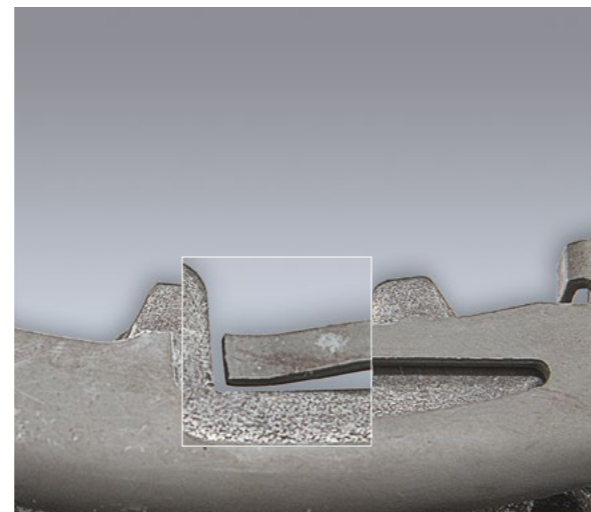

## 2 Distinguishing features of double clutch systems – 1st and 2nd generations

The first generation dry double clutch transmission system has been used in the OAM 7-speed transmission since 2008. Since then it has been constantly developed in many areas. However, the changes to date have not affected the repair process when replacing the double clutch.

Transmissions built after June 2011 were launched onto the market as the second generation of the dry double clutch transmission system. The main distinguishing features are the change to the structure of the engagement lever and engagement bearing.

The generation that is installed can be identified without disassembling the transmission. To do this, the lower soundproofing of the engine and, on some vehicles, also a cover in the area around the transmission mechatronics must be removed. The double clutch transmission system used in each case can then be identified, either from the version of the engagement lever or via the transmission construction date on the underside of the bell housing.

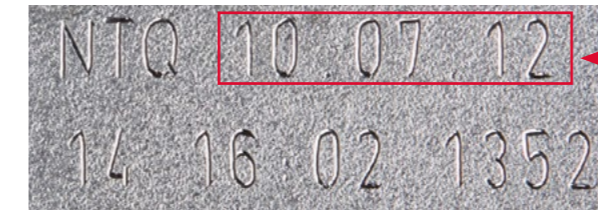

The construction date can be read off the underside of the transmission. This transmission was produced on 10/07/2012. A 2nd generation double clutch system is installed here.

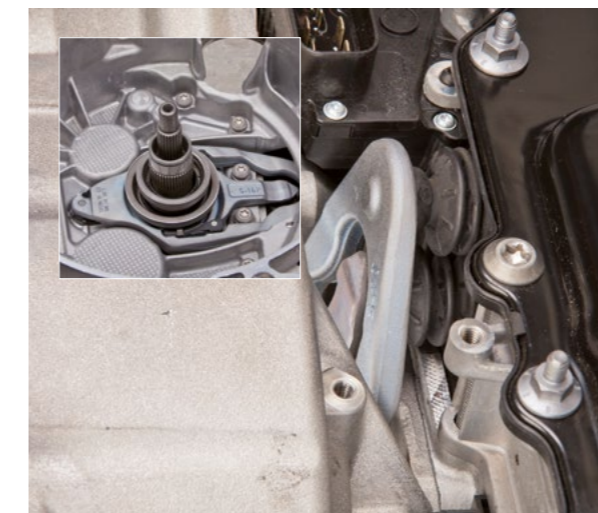
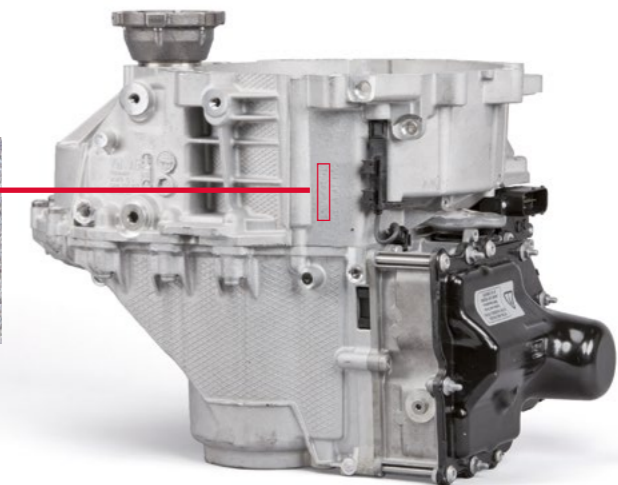

Cast engagement lever – transmission construction date up to May 2011, 1st generation OAM

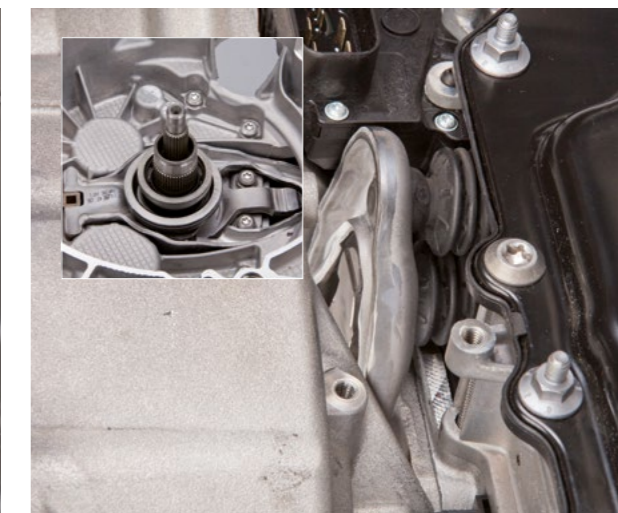

Engagement lever made from sheet steel – transmission construction date from June 2011, 2nd generation OAM and OCW

### 3 Description and scope of the LuK RepSet 2CT – 1st and 2nd generations

#### 1st generation

The LuK RepSet 2CT (Twin Clutch Technology) includes all the necessary components to replace the double clutch transmission. It is recommended that this system be entirely replaced as a matter of course due to the scope of repair required.

A combination of used parts and new parts from the LuK RepSet 2CT is not permitted. This will eliminate malfunctions such as those caused by composite installations from the outset.



- |  |                        |
|--|------------------------|
| 1 Double clutch  | 8 Clip                 |
| 2 Large engagement lever for clutch K1 including engagement bearing and guiding sleeve | 9 Mounting screws      |
| 3 Small engagement lever for clutch K2 including guiding sleeve                        | 10 Shims for clutch K1 |
| 4 Engagement bearing for clutch K2   | 11 Shims for clutch K2 |
| 5 Pilot bearing  | 12 Plug                |
| 6 Counterbearing   | 13 Clutch Disc Hub     |
| 7 Snap ring  | 14 Snap Ring           |

#### 2nd generation

The contents of the LuK RepSet 2CT are tailored exactly to the spare parts required when replacing the 2nd generation double clutch. It includes the newly redesigned engagement lever, all the necessary shims or graded spherical caps, as well as the one-piece counterbearing.

The remaining contents of the LuK RepSet are largely identical to those in the 1st generation 2CT. The components of these two systems are not compatible. A combination of used parts and new parts from the LuK RepSet 2CT is not permitted.



- |   |                             |
|---|-----------------------------|
| 1 Double clutch   | 7 Plug                      |
| 2 Large engagement lever K1 including engagement bearing and guiding sleeve | 8 Snap ring                 |
| 3 Small engagement lever K2 including guiding sleeve                        | 9 Mounting screws           |
| 4 Engagement bearing K2   | 10 Shims K2                 |
| 5 Pilot bearing   | 11 Graded spherical caps K1 |
| 6 Counterbearing  | 12 Clutch Disc Hub          |
|   | 13 Snap Ring                |



## 4 Description and scope of delivery of the LuK special tools

The LuK special tool is essential for the correct removal/installation of the dry double clutch for the OAM and OCW transmission. The double clutch must be disconnected during removal of the transmission input shaft and fitted again on installation. In addition, clutches K1 and K2 must be adjusted using washers.

The setting is also checked using the special tool.

For current and future dry LuK double clutch systems, a modular tool system has been developed by Schaeffler Automotive Aftermarket. This allows all modular units as well as the previous LuK special tool to be combined with each other.



Basic tool kit (left) and Volkswagen tool kit (right)

### 4.1 Basic tool kit

The basic tool kit (part no. 400 0418 10) represents the basis for the modular tool system. It contains those tools that are generally required for all repairs to double clutches.

In conjunction with a vehicle-specific tool kit, both supplement each other to form a complete kit for professional repairs. This is based on almost all available dry double clutch systems currently available from LuK, except for Alfa/Fiat, Jeep and Suzuki.



Part no. 400 0418 10

- |  |   |
|--|---|
| 1 Cross beam with spindle and thrust piece | 7 Transmission support with height adjustment |
| 2 3 knurled screws                         | 8 2 plugs for differential holes              |
| 3 3 M10 threaded pins, 100 mm long         | 9 DMF return tool                             |
| 4 3 M10 threaded pins, 160 mm long         | 10 Release key                                |
| 5 Snap ring pliers, angled                 | 11 Special open-end wrench                    |
| 6 Magnet                                   |   |

#### 4.2 Volkswagen tool kit (Audi, SEAT, Škoda, Volkswagen)

This vehicle-specific tool kit (part no. 400 0419 10) must be combined with the basic tool kit. It can be used to removal, installation and adjust both first generation (up to transmission construction date May 2011) and second generation (from transmission construction date

June 2011) dry double clutches in vehicles manufactured by Audi, SEAT, Škoda and Volkswagen with a 0AM and OCW transmission.



- |   |   |
|---|---|
| 1 Dial gauge with stand                         | 8 Installation pressure sleeve          |
| 2 Gauge dimension 32.92 mm (1st generation, K2) | 9 6 plugs                               |
| 3 Gauge dimension 48.63 mm (1st generation, K1) | 10 3 puller legs                        |
| 4 Gauge dimension 32.12 mm (2nd generation, K2) | 11 Adjustment gauge for gauge dimension |
| 5 Gauge dimension 48.42 mm (2nd generation, K1) | 12 2 lifting hooks                      |
| 6 3 spring loaded clamps                        | 13 Weight, 3.5 kg                       |
| 7 Removal support sleeve                        |   |

#### 4.3 Supplementary tool kit

The previous LuK double clutch special tool (part no. 400 0240 10) can be adapted to the new, modular tool system range with the supplementary tool kit (part no. 400 0420 10).

Together, the contents of the two tool kits correspond to the basic tool kit and the Volkswagen tool kit.



- |   |   |
|---|---|
| 1 Transmission support with height adjustment   | 5 Gauge dimension 48.42 mm (2nd generation, K1) |
| 2 2 plugs for differential holes                | 6 DMF return tool                               |
| 3 Special open-end wrench                       | 7 Release key                                   |
| 4 Gauge dimension 32.12 mm (2nd generation, K2) |   |



## 5 Removal and installation of the double clutch

### Changed number of small adjustment discs for clutch 2 in LuK RepSet 2CT

When replacing the double clutch, the Axial tolerances between the engagement bearings and lever springs can be balanced. For this purpose the LuK RepSet 2CT, depending on the type of gearbox, adjustment discs/ Calottes for the clutch K1, or adjusting disks for the clutch K2.

Up to now the tolerance of the engagement bearing of Clutch K2 with only one adjustment disk (illustration right) balanced. To adjust the most common setting dimensions the LuK RepSet 2CT has so far been able to cover 11 adjustment discs of different thicknesses are enclosed.

With the adjustment of the package contents, up to to two adjusting disks on the engagement bearing of the K2 permissible. This allowed the composition of the adjustment discs can be redesigned.

The new RepSet 2CT now contains 6 adjustment discs in the following numbers and strengths:

- 2 x 0.8 mm
- 1 x 1.0 mm
- 1 x 1.2 mm
- 2 x 1.4 mm

With this set it is still possible to create the required 11 setting dimensions (individually or by combining two setting discs).

The table below shows how the required adjustment dimensions can be achieved with the respective set of adjustment discs.

Required adjustment dimension	Setting disks to be used with the 11-piece set	Setting washers to be used or combinations for 6-piece set
0.8 mm	1 x 0.8 mm	1 x 0.8 mm
1.0 mm	1 x 1.0 mm	1 x 1.0 mm
1.2 mm	1 x 1.2 mm	1 x 1.2 mm
1.4 mm	1 x 1.4 mm	1 x 1.4 mm
1.6 mm	1 x 1.6 mm	2 x 0.8 mm
1.8 mm	1 x 1.8 mm	1 x 0.8 mm + 1 x 1.0 mm
2.0 mm	1 x 2.0 mm	1 x 0.8 mm + 1 x 1.2 mm
2.2 mm	1 x 2.2 mm	1 x 0.8 mm + 1 x 1.4 mm
2.4 mm	1 x 2.4 mm	1 x 1.4 mm + 1 x 1.0 mm
2.6 mm	1 x 2.6 mm	1 x 1.4 mm + 1 x 1.2 mm
2.8 mm	1 x 2.8 mm	2 x 1.4 mm

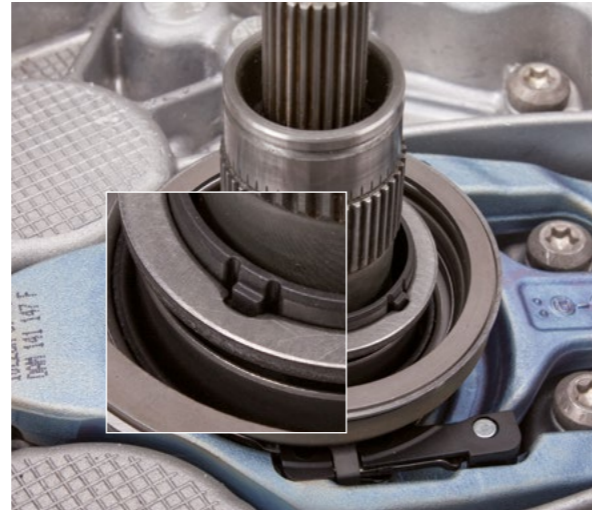

**Note:**

During the changeover, mixed stocks may occur. Therefore, the RepSet 2CT can contain both 11 and 6 adjustment discs for K2 during the transition period.

### 5.1 Notes on repairs

**Valid for:**

OAM, OCW 7-speed double clutch transmission in Audi, SEAT, Škoda and Volkswagen (first and second generation)

**In combination with:**

LuK RepSet 2CT

**Using the special tools:**

- Part no. 400 0418 10 in conjunction with 400 0419 10
- Part no. 400 0240 10 in conjunction with 400 0420 10

**Important information for proper repairs:**

- Repairs should only be performed by qualified personnel and with appropriate workshop tools
- Due to the constant technical developments in series production introduced by the vehicle manufacturer, changes in the repair process (e.g. gauge dimensions) or the required special tools may arise
- As a rule, a repair must be carried out using the latest repair instructions and with the relevant special tools

**Current data and information on this can be found at:**

[www.repxpert.com](http://www.repxpert.com)

- If transmission oil escapes during the repair, it must be drained fully. The transmission must be refilled with the quantity of oil specified by the manufacturer. If oil is leaking from the mechatronics, it must not be topped up or replaced. In this case, the entire mechatronics unit must be replaced, taking into account the specifications of the vehicle manufacturer
- We recommend that you check the dual mass flywheel (DMF) and replace if necessary when replacing the clutch. Particular attention must be paid to the gearing and the bracing plate (as described in Chapter 1.7) during this process
- As with the repair of a standard clutch, the pilot bearing must be checked and replaced as necessary when replacing the double clutch
- Before installing the double clutch, the transmission input shafts must be cleaned thoroughly and checked for damage. The splines must then be lubricated with a suitable lubricant. The vehicle manufacturer's instructions are to be observed as a priority. If no specifications about the lubricant are made by the

vehicle manufacturer, high-melting point greases (e.g. Castrol Olista Longtime 2 or 3) that are temperature-resistant and resistant to ageing can be used as alternative lubricants

- It is important to ensure that only the transmission input shafts are lubricated. All other components of the engagement and clutch system must not be greased or oiled
- The bearing seat on the hollow shaft must be moistened with a drop of transmission oil across the entire circumference before the double clutch is pressed on
- After installing the clutch and transmission, the basic setting of the system must be performed using a suitable diagnostic tool
- Generally speaking, each LuK RepSet 2CT must be installed in its entirety. A combination of used parts and new parts from the LuK RepSet is not permitted
- Oily and/or dirty transmission parts must be cleaned before using new components. Cleanliness must be ensured throughout the entire repair process

**Note:**

The clutch must not be dropped under any circumstances. As a rule, vibrations should be avoided, as they may have a negative impact on the adjuster.

### 5.2 Brief description of the repair process

- Remove the transmission
- Disconnect the clutch from the transmission input shaft (hollow shaft)
- Remove the old components of the engagement system
- Install the new components of the engagement system
- Position the engagement bearings with shims
- Press the new clutch onto the hollow shaft
- Check the clearance of the clutch discs
- Install the transmission
- Perform a basic setting of the system with a suitable diagnostic system

### 5.3 Removal of the double clutch

**Note:**

Remove the transmission according to the vehicle manufacturer's specifications!

- Disconnect the vent caps from the transmission (1) and mechatronics (2) and fit plugs (KL-0500-607)

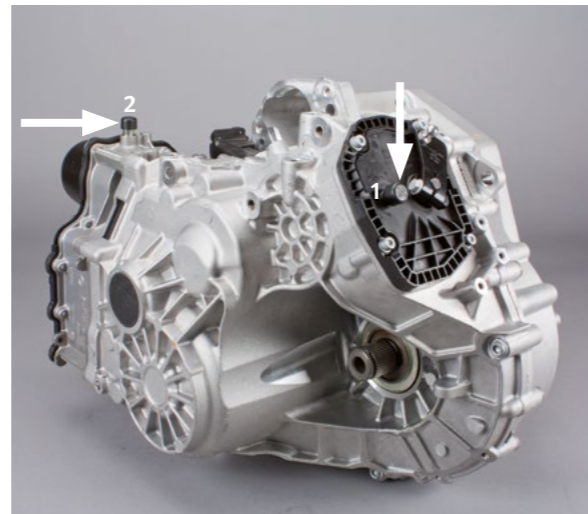

- Remove the snap ring from the upper clutch disc hub (K1) with a screwdriver

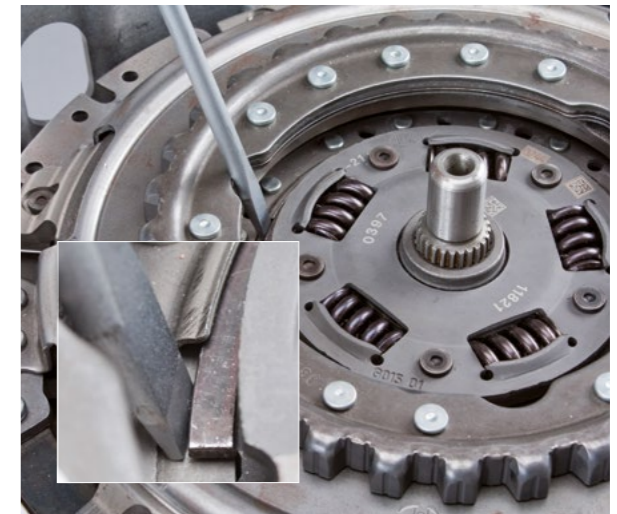

**Note:**

If transmission oil is leaking from the transmission during the repair, it must be drained fully. The transmission must be refilled with the quantity of oil specified by the manufacturer!

If oil is leaking from the mechatronics, it must not be topped up or replaced. In this case, the entire mechatronics unit must be replaced taking into account the specifications of the vehicle manufacturer!

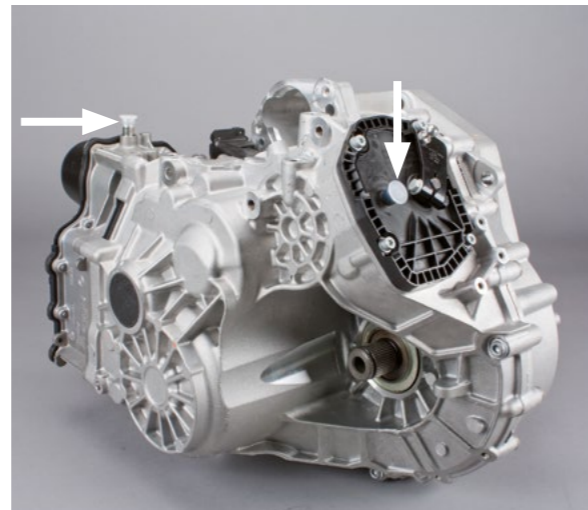

- Remove the snap ring and clutch disc hub (K1)



- Mount transmission on an installation device

or

- Place transmission on a workbench and position in a stable horizontal position facing upwards with the transmission support (KL-0500-802) from the basic tool kit



- Remove the snap ring from the hollow shaft with the snap ring pliers (KL-0192-12); this will damage the ring and it must be replaced

**Note:**

If the snap ring in the groove of the hollow shaft cannot be removed, the clutch must be pressed down slightly using the special tool kit, as shown on page 40.





### 5.3 Removal of the double clutch

- Position the clutch in the bell housing so that there is sufficient space for locating in the puller legs
- Insert 3 puller legs (KL-0500-6041) on the clutch installation

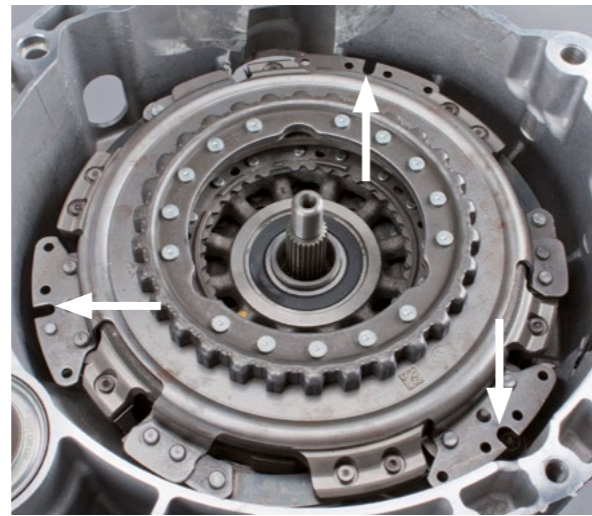

- Install in the first leg between the clutch bell housing and clutch and pull upwards; this inserts the centring pin on the bottom of the clutch into the recess on the leg



- Insert the spring-loaded clamp horizontally into the leg
- Withdraw the plunger against the spring force; rotate by 90° and install on the clutch

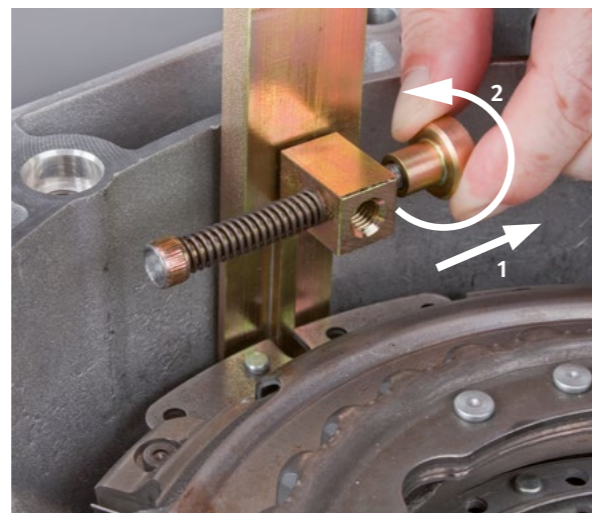

- The leg is in the desired position
- Repeat the process with the remaining two legs

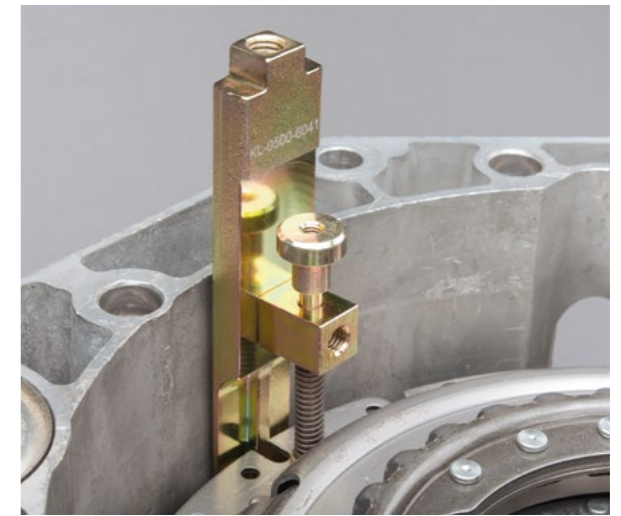

- Place the support sleeve (KL-0500-6030) on the hollow shaft

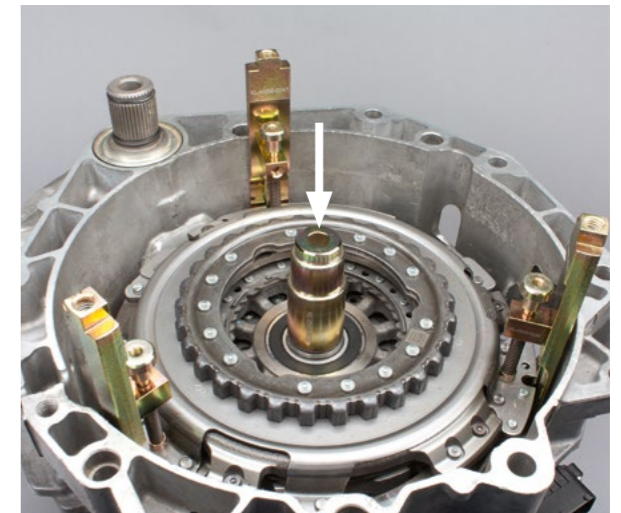

- Mount the cross beam (KL-0500-60) on the support sleeve and legs
- Position the spindle so that the legs can be mounted on the cross beam free from tension using the knurled screws

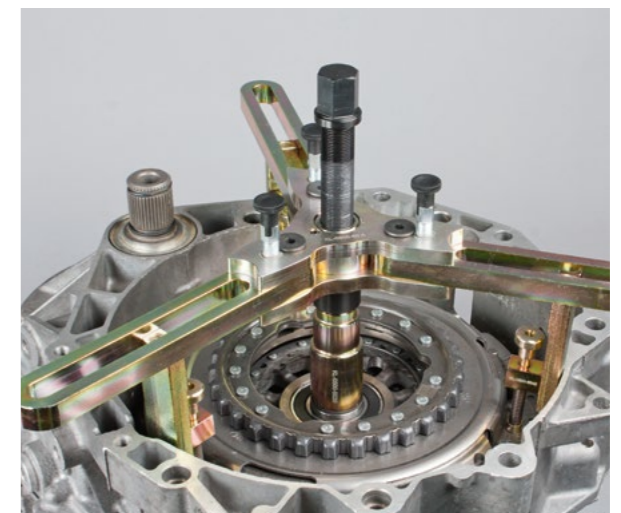



### 5.3 Removal of the double clutch

- Screw the knurled screws into the legs by hand

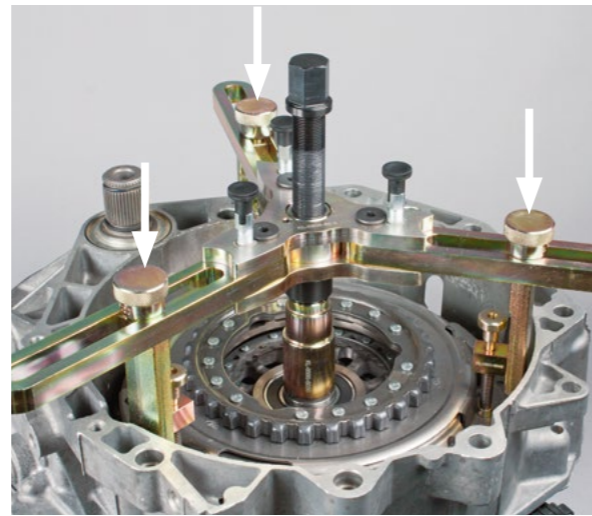

- Tighten 3 countersunk-socket head screws on the cross beam

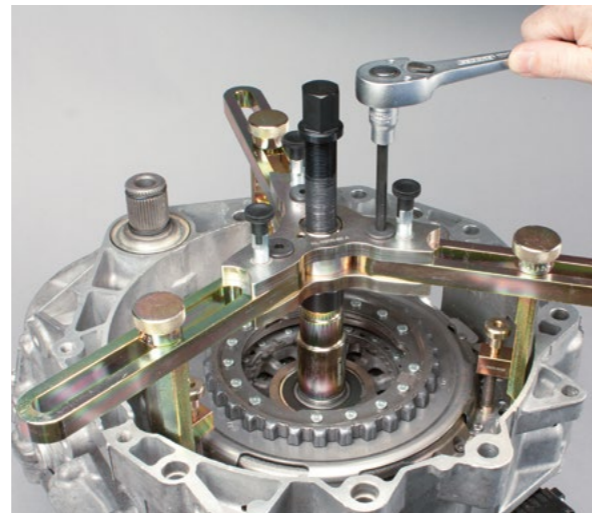

- Remove the clutch from the hollow shaft by turning the spindle



- Remove the clutch assembly with the cross beam

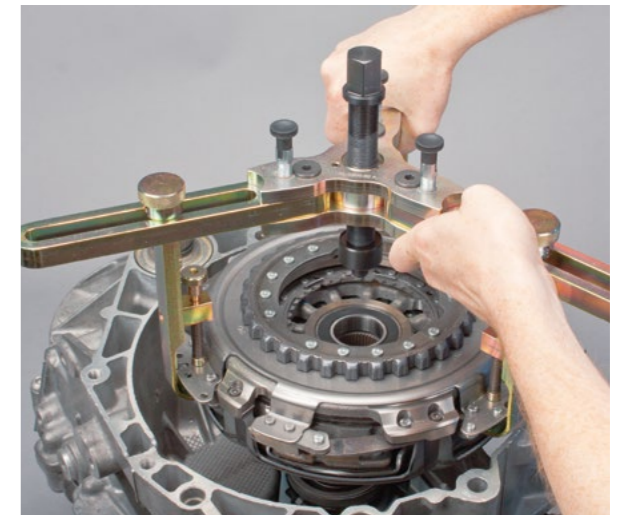

### 5.4 Removal of the engaging system – 1st generation

- Remove the small engagement bearing (K2) with the shim. Depending on vehicle model year the shim is positioned below or above engagement bearing



- Remove the large clutch engagement bearing (K1) with the shim and engagement lever





### 5.4 Removal of the engaging system

- Remove both screws from the retaining plate (Torx T30)

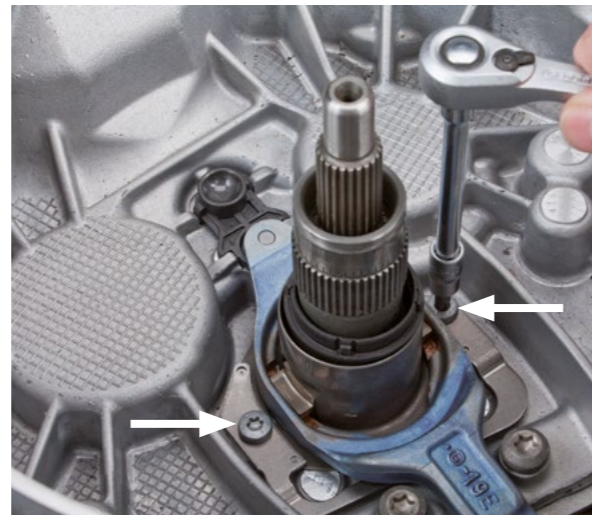

- Remove the retaining plate and engagement lever; this retaining plate is different on some of the previous transmission versions



- Remove the counterbearing from the engagement lever



- Thoroughly clean the transmission input shafts
- Check the radial shaft oil seals rings on the transmission input shafts for leaks

**Note:**

The bearing seat of the hollow shaft must be cleaned and must be in good condition!  
An oxidised or damaged bearing seat will increase the force when pressing on the clutch to an unacceptable level and consequently damage the bearing arrangement of the hollow shaft in the transmission!



### 5.5 Installation of the engaging system – 1st generation

- Insert a new counterbearing for the engagement lever; it only fits in one position



- Mount a new small engagement lever (for K2) with a guiding sleeve and new retaining plate; the retaining plate sits on the shoulder of the guiding sleeve
- Tighten the new screws to 8 Nm + 90°
- Ensure the engagement lever is positioned correctly on the counterbearing

**Note:**

Do not grease or oil components!

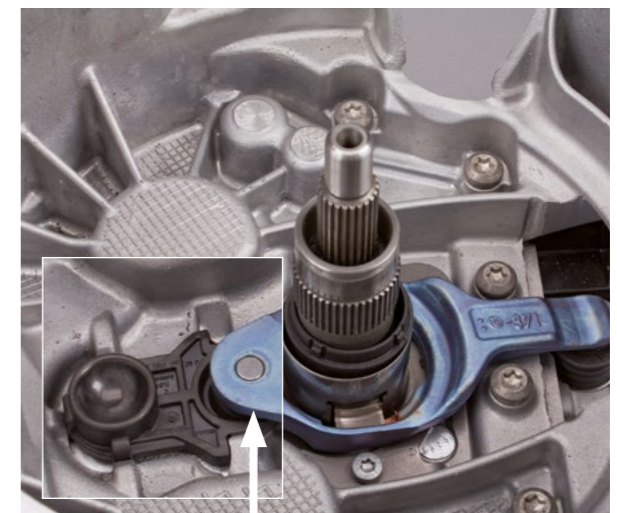



### 5.5 Installation of the engaging system – 1st generation

- Ensure the engagement lever is positioned correctly on the mechatronics actuator



- Insert a new large engagement lever with engagement bearing (for K1)
- Ensure the engagement lever is positioned correctly on the counterbearing

**Note:**

Do not grease or oil components!



- Ensure the engagement lever is positioned correctly on the actuator



- Equip the large engagement bearing (for K1) with the strongest adjustment disk (2.8 mm)



- Mount the strongest adjustment disc or adjustment disc combination (2.8 mm) for the small engagement bearing (K2)
- Make sure that the lugs are seated in the grooves of the adjusting disc/s

**Note:**

For the small engagement bearing K2, up to 2 adjustment discs may be used with immediate effect. Therefore the LuK RepSet 2CT now contains only 6 (instead of 11) adjustment discs for the K2. However, it is still possible to create all the required adjustment dimensions either with one or by combining two adjustment discs. Detailed information on the adjustment discs and their possible combinations can be found in chapter 5 on page 16.

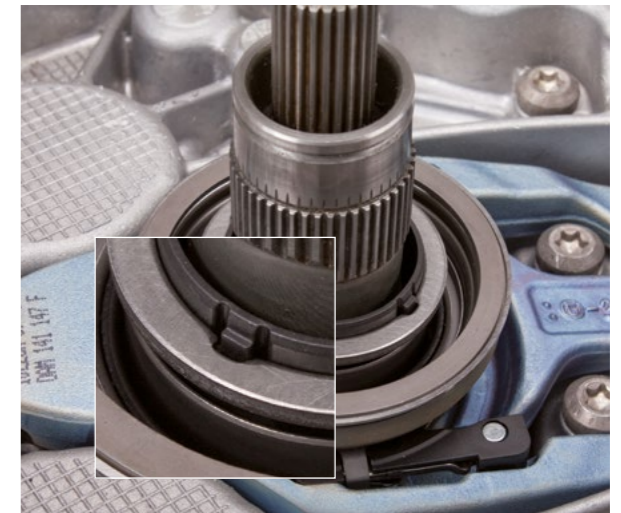

- Insert a small engagement bearing (for K2)
- Make sure that the lugs sit in the cutouts of the engagement bearing





### 5.6 Removal of the engaging system – 2nd generation

- Remove small engagement bearing (for K2) with adjusting disc/s

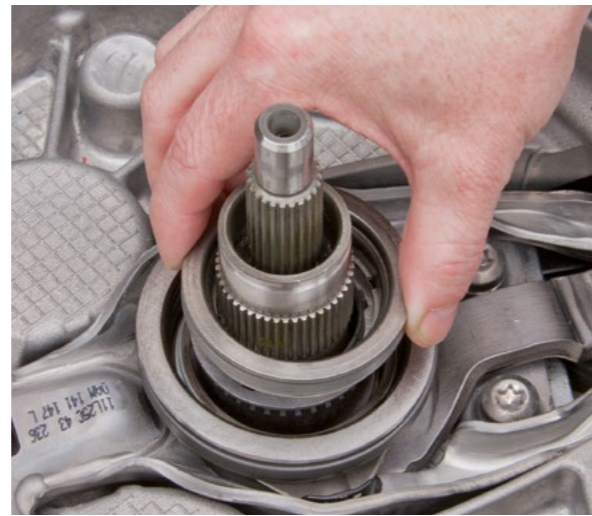

- Remove the large clutch engagement bearing (for K1) with the graded spherical cap and engagement lever



- Remove both screws (Torx T30) from the guiding sleeve

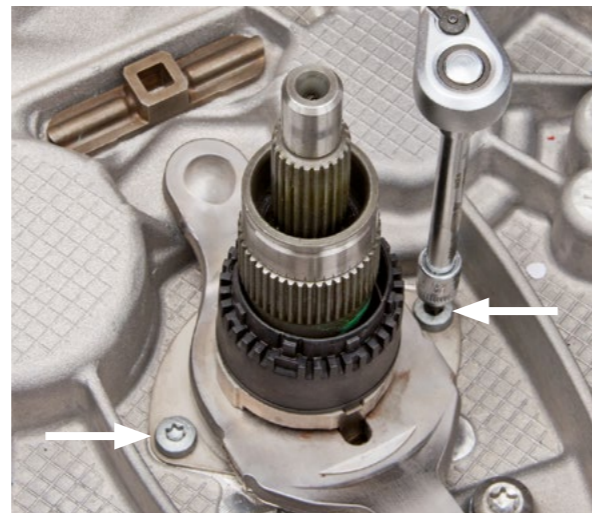

- Remove the small engagement lever (K2)

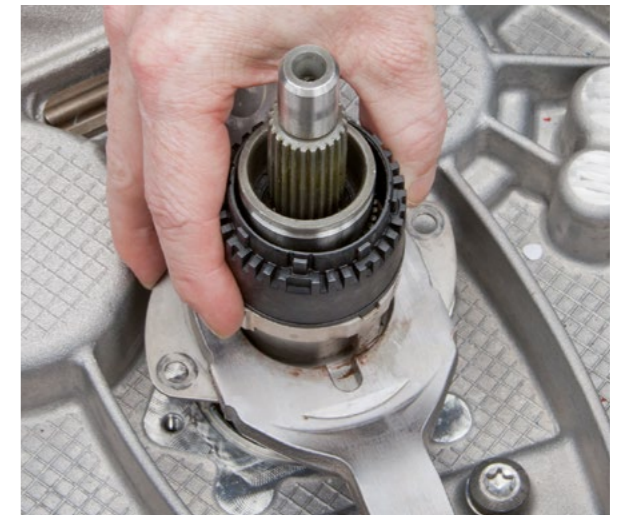

- Remove the counterbearing from the small engagement lever (1)
- The counterbearing of the large engagement lever (2) remains in the transmission



- Thoroughly clean the transmission input shafts
- Check the radial shaft oil seals on the transmission input shafts for leaks

**Note:**

The bearing seat of the hollow shaft must be cleaned and must be in good condition! An oxidised or damaged bearing seat will increase the force when pressing on the clutch to an unacceptable level and consequently damage the bearing arrangement of the hollow shaft in the transmission!





### 5.7 Installation of the engaging system – 2nd generation

- Insert the new counterbearing for the small engagement lever



- Mount a new small engagement lever (K2) with a guiding sleeve
- Tighten the new screws (Torx T30) to 8 Nm + 90°

**Note:**

Do not grease or oil components!



- Ensure the small engagement lever for K2 is positioned correctly on the counterbearing and on the mechatronics actuator

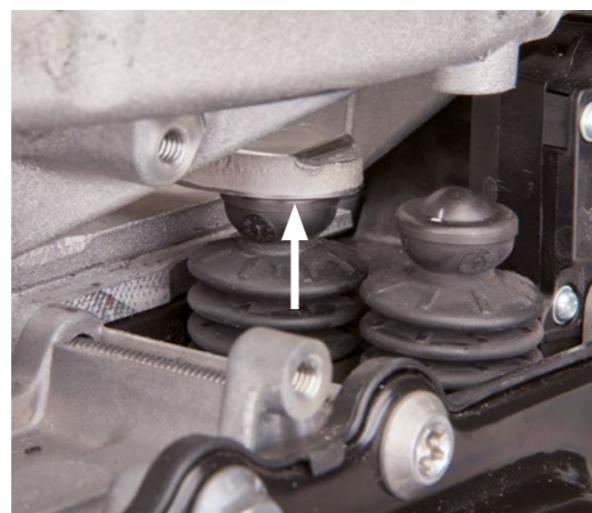

- Install a large engagement bearing (K1) with the engagement lever



- Ensure the large engagement lever K1 is positioned correctly on the counterbearing and on the mechatronics actuator



- Install the thickest shim for the small engagement bearing; make sure that the lugs of the sleeve are sitting in the cutouts in the disc





### 5.7 Installation of the engaging system – 2nd generation

- Mount the thickest adjustment disc or adjustment disc combination (2.8 mm) for the small engagement bearing (K2)
- Make sure that the lugs are seated in the grooves of the adjusting disc/s

**Note:**

For the small engagement bearing K2, up to 2 adjustment discs may be used with immediate effect. Therefore the LuK RepSet 2CT now contains only 6 (instead of 11) adjustment discs for the K2. However, it is still possible to create all the required adjustment dimensions either with one or by combining two adjustment discs. Detailed information on the adjustment discs and their possible combinations can be found in Chapter 5 on page 16.

- Insert small engagement bearing (for K2)
- Make sure that the lugs are in the grooves of the sitting in the insert bearing



### 5.8 Setting the engaging system – 1st and 2nd generations

- For the 1st generation engagement system, use the gauge with a dimension of 48.63 mm (KL-0500-6033; Gold) on the large engagement bearing (for K1)
- For the 2nd generation engagement system, use the gauge with a dimension of 48.42 mm (KL-0500-6081; Black) on the large engagement bearing (for K1)

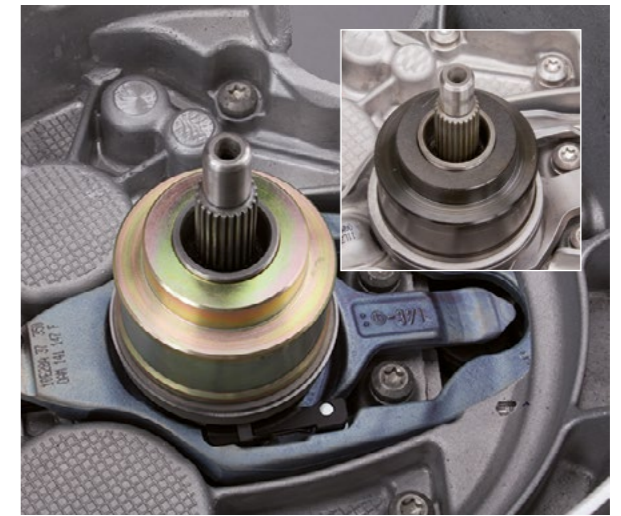

- Place the 3.5 kg weight (KL-0500-6034) on the gauge; this achieves the specified preload



- Check that the adjustment gauge (KL-0500-6035) can be slid into the snap ring groove on the hollow shaft

**Note:**

The gauge must not be pushed down.

The gauge can easily be slid into the snap ring groove without the use of force!

- If this is not possible, replace the installed shim/graded/spherical cap with the next thinnest shim/graded/spherical cap and try again to slide the adjustment gauge into the snap ring groove





## 5.8 Setting the engaging system – 1st and 2nd generations

- Repeat until the adjustment gauge can be slid into the snap ring groove without using force; if all three sides of the adjustment gauge fit into the snap ring groove, this is the shim/graded spherical cap for the nominal dimension of K1

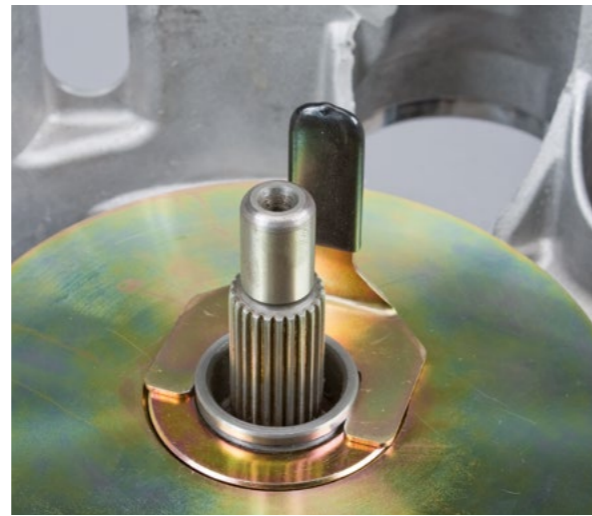

- Check whether the correct shim/graded spherical cap has been used; using the relevant engagement lever, attempt to push the engagement bearing axially against the adjustment gauge with the gauge dimension mounted

**Note:**

The gauge dimension should not move, or should only move slightly (max. 0.1 mm)!

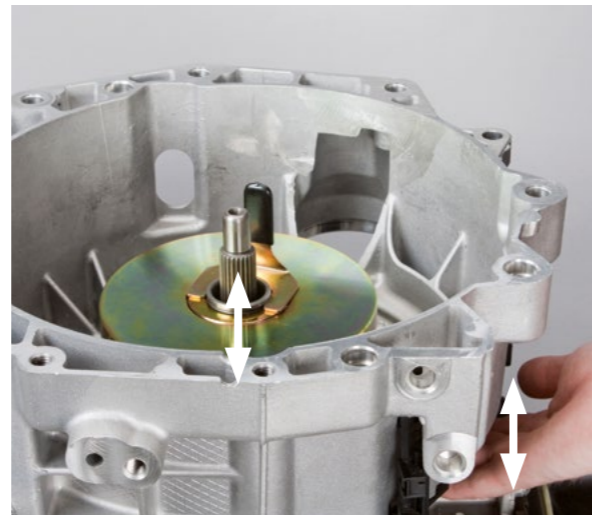

- Shim/graded spherical cap for the nominal dimension needs to be adjusted to match the individual tolerance of clutch K1

**Note:**

The tolerance value is printed on the engine side of the clutch. It is marked as K1 and is between  $-0.40$  mm and  $+0.40$  mm.

- Subtract or add the individual tolerance to the previously determined shim/graded spherical cap according to what is printed



**Example 1**

Calculated shim/graded spherical cap for nominal size of clutch K1: 1.8 mm

Tolerance value for clutch K1:  $-0.2$  mm

- $1.8$  mm  $- 0.2$  mm =  $1.6$  mm

The shim/graded spherical cap to be installed for clutch K1 has a thickness of 1.6 mm.

**Example 2**

Calculated shim/graded spherical cap for nominal size of clutch K1: 2 mm

Tolerance value for clutch K1:  $+0.4$  mm

- $2$  mm  $+ 0.4$  mm =  $2.4$  mm

The shim/graded spherical cap to be installed for clutch K1 has a thickness of 2.4 mm.



- Insert the theoretical shim/graded spherical cap in the large engagement bearing (K1) and make sure that the shim/graded spherical cap is sitting in the designated recess

**Note:**

The final shim can be glued on with three drops of superglue for the 1st generation engagement system so that it does not slip when the double clutch is installed.



- For the 1st generation engagement system, use the gauge with a dimension of 32.92 mm (KL-0500-6032; Gold) on the small engagement bearing (for K2)

- For the 2nd generation engagement system, use the gauge with a dimension of 32.12 mm (KL-0500-6082; Black) on the small engagement bearing (for K2)





## 5.8 Setting the engaging system – 1st and 2nd generations

- Place the 3.5 kg weight (KL-0500-6034) on the gauge; this achieves the specified preload



- Check that the adjustment gauge (KL-0500-6035) can be slid into the snap ring groove on the hollow shaft

**Note:**

The adjustment dimension must not be pressed down. The gauge can be pushed into the groove easily and without force!

- If this is not possible, replace the mounted adjusting disc(s) with the next thinner adjusting disc(s) (or their combination) and try again to push the adjusting gauge into the retaining ring groove



- Repeat until the setting gauge can be pushed non-violently into the circlip groove; this determines the suitable setting plate(s) for the nominal dimension of clutch K2

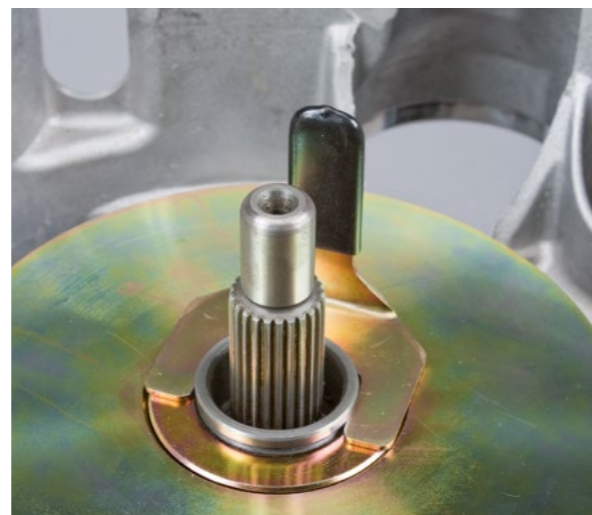

- Check whether the correct adjustment disk(s) has/have been inserted; for this purpose, use the corresponding engagement lever to attempt to move the engagement bearing with the attached adjustment dimension axially against the adjustment gauge

**Note:**

The gauge should not move, or should only move slightly (max. 0.1 mm)!

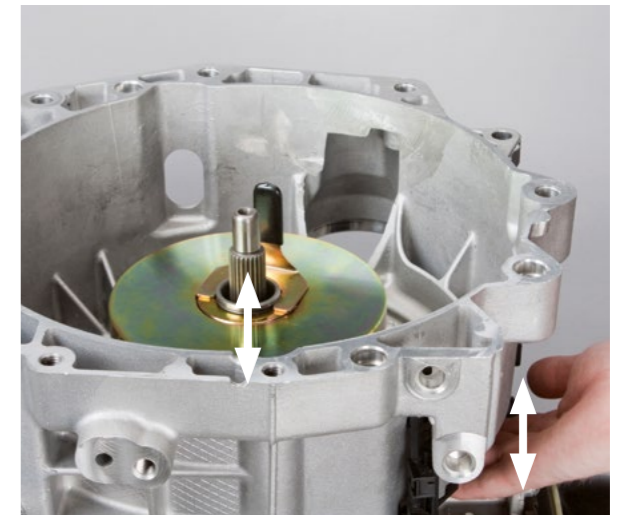

- Adjust the setting disk/s for the nominal dimension by the individual tolerance of clutch K2

**Note:**

The tolerance value must be read on the engine side of the clutch. It is marked as K2 and is between -0.40 mm and +0.40 mm.

- Subtract or add the individual tolerance value from or to the previously determined dial(s) according to the sign



**Example 1**

Determined total thickness of the dial/s for the nominal dimension of the coupling K2: 1.8 mm  
Tolerance value of coupling K2: -0.2 mm  
•  $1.8 \text{ mm} - 0.2 \text{ mm} = 1.6 \text{ mm}$   
The adjusting disk(s) to be installed for the clutch K2 has/have a total thickness of 1.6 mm.

**Example 2**

Determined total thickness of the dial/s for the nominal dimension of the coupling K2: 2 mm  
Tolerance value of coupling K2: +0.4 mm  
•  $2 \text{ mm} + 0.4 \text{ mm} = 2.4 \text{ mm}$   
The adjusting disk(s) to be installed for the clutch K2 has/have a total thickness of 2.4 mm





### 5.8 Setting the engaging system – 1st and 2nd generations

- Insert the calculated adjustment disc/s, mount the engagement bearing (for K2) and ensure that the lugs are seated in the grooves of the adjustment disc/s and the engagement bearing



### 5.9 Preparation of the transmission input shafts

- Prepare 2 pea-sized portions (0.2 g each) of lubricant on a piece of cardboard

**Note:**

Take the vehicle manufacturer's specifications into account when choosing the lubricant. If no information is available, a high-melting point grease (e.g. Castrol Olista Longtime 2 or 3) that is temperature-resistant and resistant to ageing can be used.



- Apply a portion of lubricant to the splines of the hollow shaft with a brush
- Apply the other portion to the splines of the solid shaft with the brush

**Note:**

If too much lubricant is used, this can cause a failure of the double clutch!



### 5.9 Preparation of the transmission input shafts

- Moisten the bearing seat on the transmission input shaft with a drop of transmission oil across the entire circumference

**Note:**

If too much lubricant is used, this can cause a failure of the double clutch!

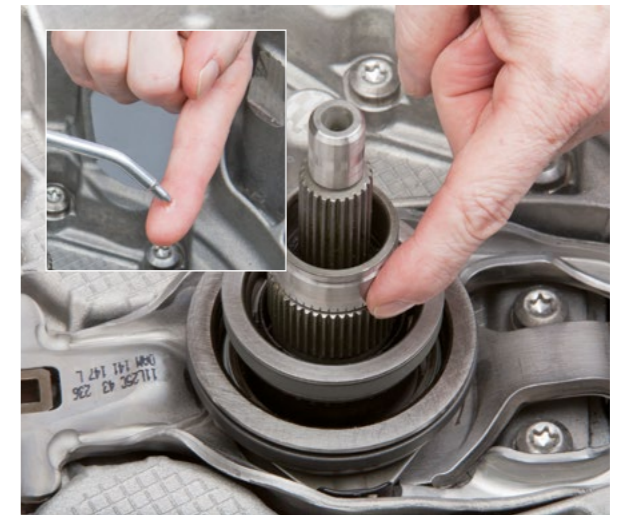

### 5.10 Installation of the double clutch

- Place the new clutch assembly on the hollow shaft; the turning it slightly will ensure that the splines of the clutch disc K2 and the hollow shaft engage



- Check that the clutch is sitting properly on the shaft; to do this, measure the distance between the upper edge of the bearing inner ring and the face of the hollow shaft; it must not exceed 8 mm

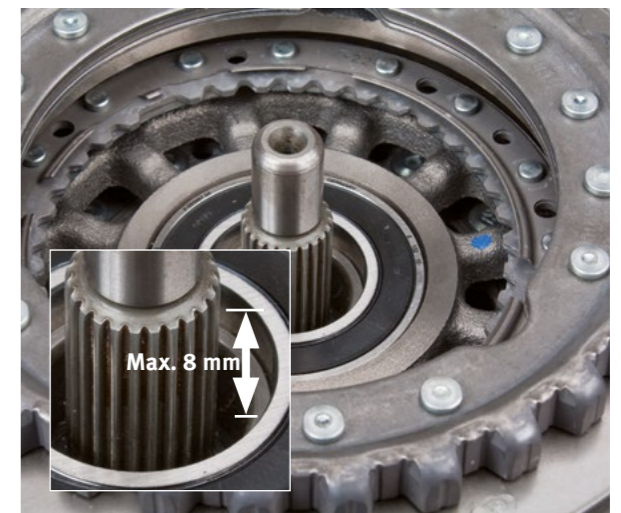



### 5.10 Installation of the double clutch

- Place the pressure sleeve (KL-0500-6031) on the bearing inner ring of the clutch package

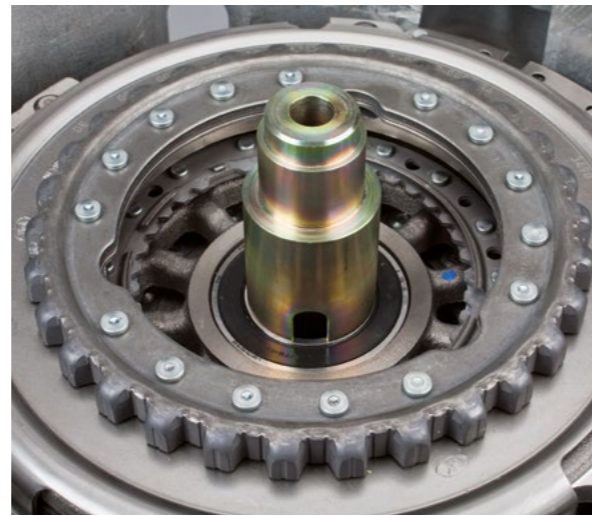

- Mount 3 threaded adaptors (KL-0500-6021 or KL-0500-6022) with collar nuts on the transmission bell housing

**Note:**

Adaptors with a long or short thread are used depending on the mounting options on the transmission.

- Position threaded adaptors at an angle of approximately 120° to each other

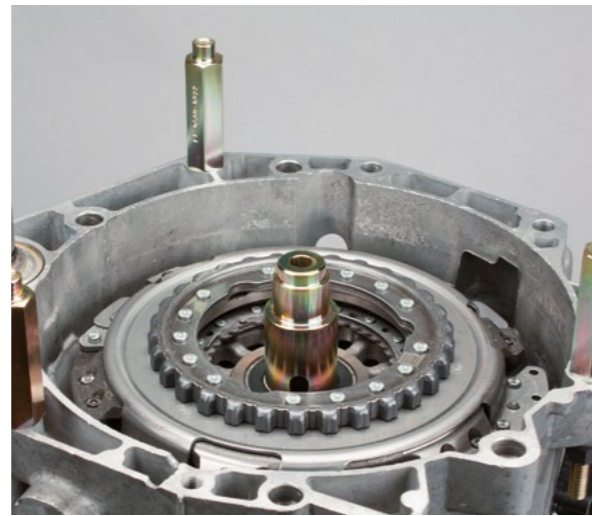

- Loosen 3 countersunk-socket head screws on the cross beam

- Mount the cross beam (KL-0500-60) on the threaded adaptors with the knurled screws (KL-0500-6020) so that they are free from tension

**Note:**

The spindle must be centred in relation to the clutch, must be inserted into the pressure sleeve and must move freely.

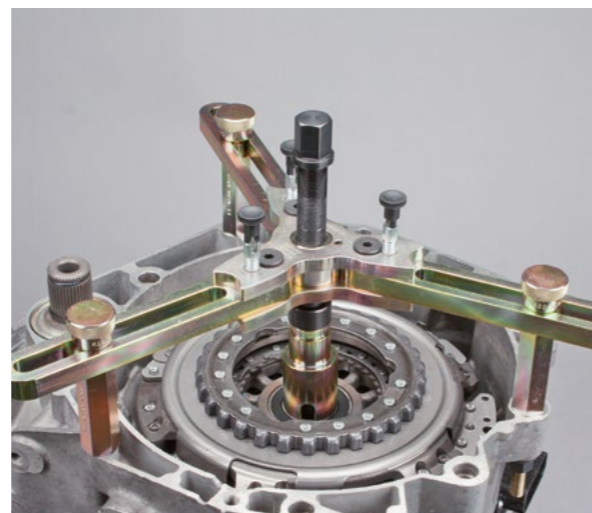

- Tighten the 3 countersunk-socket head screws on the cross beam

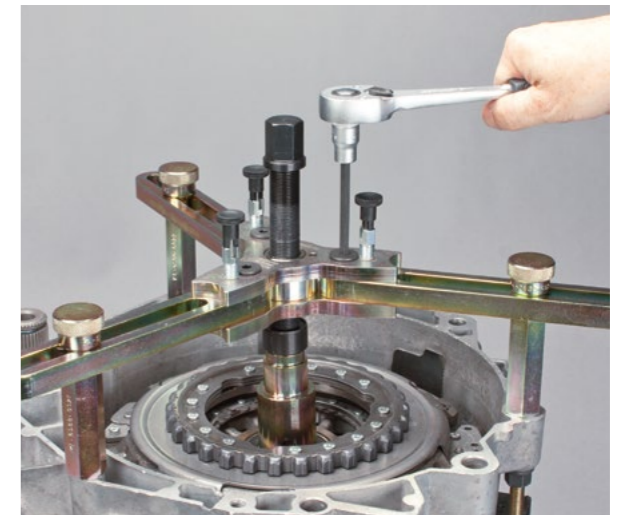

- Press the clutch onto the hollow shaft by turning the spindle at the pressure sleeve; this process is complete as soon as the full snap ring groove can be seen in one of the windows on the pressure sleeve and the force required to turn the spindle increases noticeably

**Note:**

The bearing arrangement of the hollow shaft will be damaged if the spindle is turned any further. This will result in damage to the transmission!

**Note:**

The spindle should be rotated with a torque wrench that is set to the maximum permissible torque of 12 Nm. The force required to turn the spindle must not cause the torque wrench to be triggered! If it is triggered before the clutch has reached its end position, there is an error!

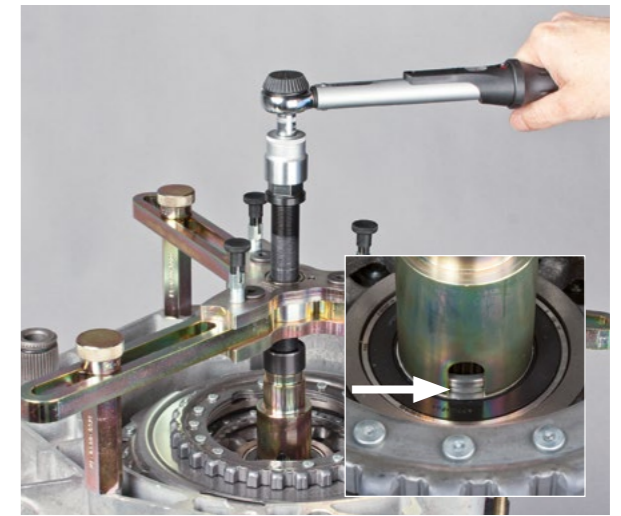

- Mount the snap ring on the hollow shaft with snap ring pliers (KL-0192-12)

**Note:**

The side of the snap ring on which the opening is smaller faces upwards.

- As a rule, use a new snap ring

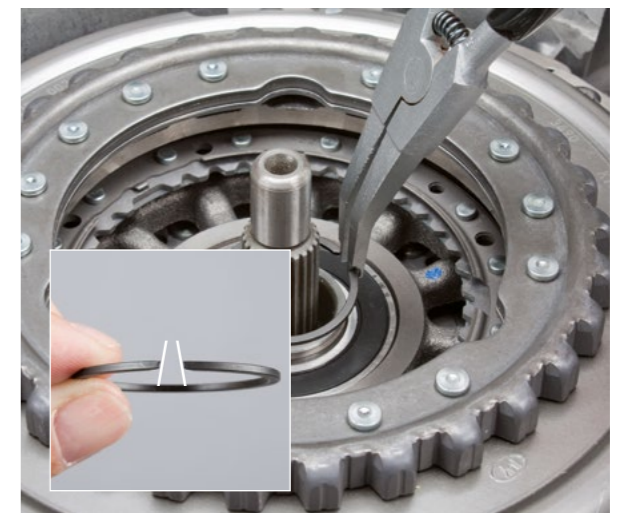



### 5.10 Installation of the double clutch

- Check the clearance of the lower clutch disc (K2)
- Install the dial gauge on the clutch bell housing with the stand (ND-0500-606) and the collar nut
- Place the preloaded test probe on the lower clutch disc and set the dial gauge to zero

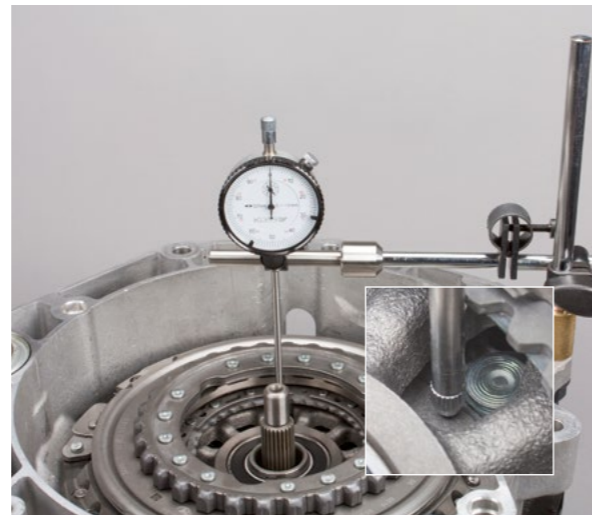

- Insert both lifting hooks into the clutch disc hub and lift until it stops
- Read off the clearance from the dial gauge

**Note:**

This measurement is taken in three places, each offset by 120°.



**Note:**

The clearance (actual clearance of the clutch disc) must be between 0.3 and 1 mm at all measuring points. The measured values must not differ from each other by more than 0.3 mm. If the clearance is outside the tolerance value, the adjustment is incorrect and must be repeated. It is possible that the setting disk(s) was/are not positioned correctly.

- Once the measurement is complete, swivel the dial gauge to the side, but do not remove; the measuring device is required again to measure the clearance of the upper clutch disc



- Install the clutch disc hub for the upper clutch (K1)

**Note:**

The hub can only be used in one position due to the wider gear tooth.

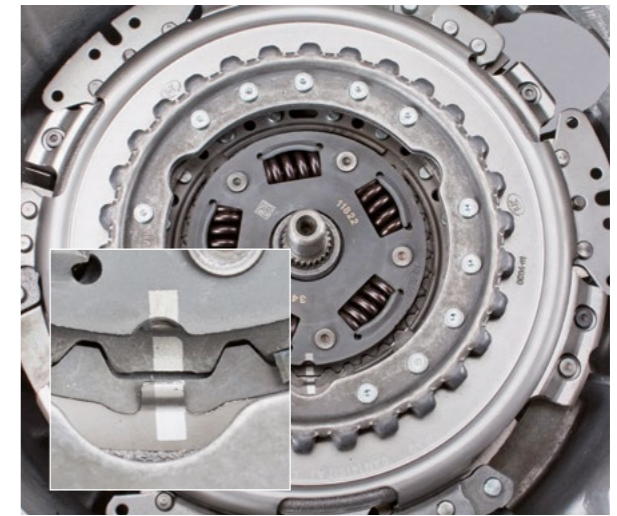

- Insert the snap ring

**Note:**

The position of the ring must be centred in relation to the sheet metal tab, i.e. in relation to the large gear tooth.



- Check the clearance of the upper clutch disc (K1); place the preloaded test probe on the hub of the upper clutch disc

**Note:**

This measurement is taken in three places, each offset by 120°.

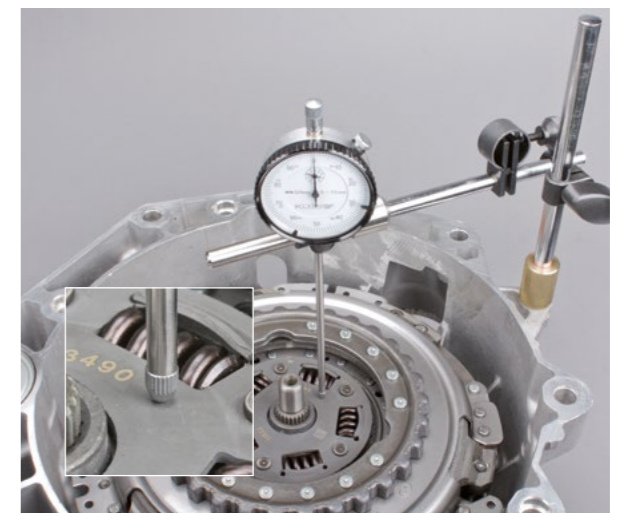



### 5.10 Installation of the double clutch

- Insert both lifting hooks into the clutch disc hub and lift until it stops
- Read off the clearance from the dial gauge



**Note:**

The clearance (actual clearance of the clutch disc) must be between 0.3 and 1 mm at all measuring points. The measured values must not differ from each other by more than 0.3 mm. If the clearance is outside the tolerance value, the adjustment is incorrect and must be repeated. Possibly the adjustment disc/ calotte was not positioned correctly.



- Put the transmission in the installation position



- Reinstall the transmission according to the vehicle manufacturer's specifications
- Remove the plugs from both vent connections and attach the caps

**Note:**

It must be possible to bring the engine and transmission together far enough for the engine and transmission mounting faces to make full contact. Only then should the components be bolted together. Failure to observe this instruction may result in damage to the double clutch!

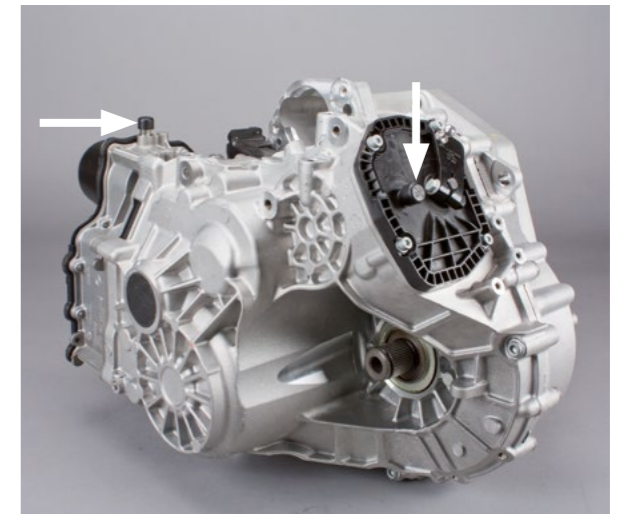

**Note:**

If transmission oil escapes during the repair, it must be drained fully. The transmission must be refilled with the quantity of oil specified by the manufacturer. The existing oil cannot be topped up!

If oil is leaking from the mechatronics, it must not be topped up or replaced. In this case, the entire mechatronics unit must be replaced taking into account the specifications of the vehicle manufacturer!

- Finally, a basic setting of the clutch system must be carried out with a suitable diagnostic tool





