



VARTA BLUE dynamic EFB

Key Benefits vozila



Spremno za ulazne start-stop sustave.



Projektirano prema najvišim njemačkim standardima.



Patentirana PowerFrame® rešetka za pouzdanu snagu pokretanja, brzo punjenje i otpornost na koroziju.



Velika sposobnost dubokog pražnjenja

Za više informacija posjetite varta-automotive.com

PODACI O NARUDŽBI

Europski tipski br. (ETN):	560500064
Article number:	560500064D842
Kratki kod:	N60
Bar kod:	4016987152300
UK kod:	027EFB
Jedinica pakiranja:	1
Paleta / Karton:	63

TEHNIČKI INFORMACIJE

Voltaža [V]:	12	Base Hold-down:	B13
Kapacitet Baterije [Ah]:	60	Raspored:	0
Struja Hladnog Starta [A]:	640	Vrste terminala:	1
Dužina [mm]:	242	Veličina kućišta:	H5/LN2
Širina [mm]:	175	Težina (kad nije napunjen):	16,93
Visina [mm]:	190		

B13

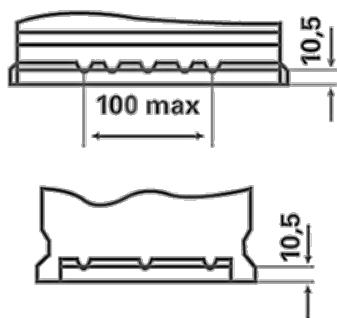

0

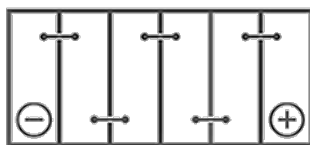

1

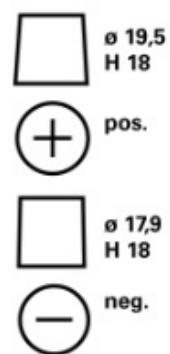

3

