

# SLI Battery For passenger vehicles

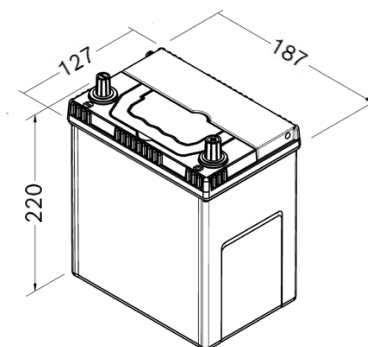

## Part information

Part No:	0092PP0180
Short code:	PP018
Product line:	Power Plus
Technology:	SLI - Starting-Lighting-Ignition*
EAN code:	404702654410
Box color	Black



## Technical information

Nominal Voltage:	12 V		
Nominal capacity: (EN / 20 hr discharge down to 10.5 V)	C20	36 Ah	
Cold cranking amps: (EN / -18°C U10s ≥ 7.5 V)	360 A		
Group size:	B19		
JIS type:	Yes		
Short-time angle of inclination:	55°		
Permanent angle of inclination:	0°		
Dimension:	Length 187 mm	Width 127 mm	Ht. w terminal 220 mm
Total battery weight: (approx., filled battery)	8,9 kg		
Layout: (ETN, DIN 72331)	ETN 0		
Terminal: (ETN, DIN 72331)	JIS taper post		
Base hold down: (ETN, DIN 72331)	B00		
Degassing:	Central		

## Technical data

Application:	Conventional
Service:	Maintenance-free
Standard charging:	Charging voltage: 14,4 V
	Charging current: 3,6 A
	Charging pattern: IU
Standards:	DIN EN 60095-1, -2, -4 Lead-acid starter batteries; DIN EN 50342 Lead-acid starter batteries; DIN 41 773, Charger with IU characteristics

\*SLI (Starting-lighting-ignition): lead-acid starting-lighting-ignition/starter battery